

VOORGEVEL

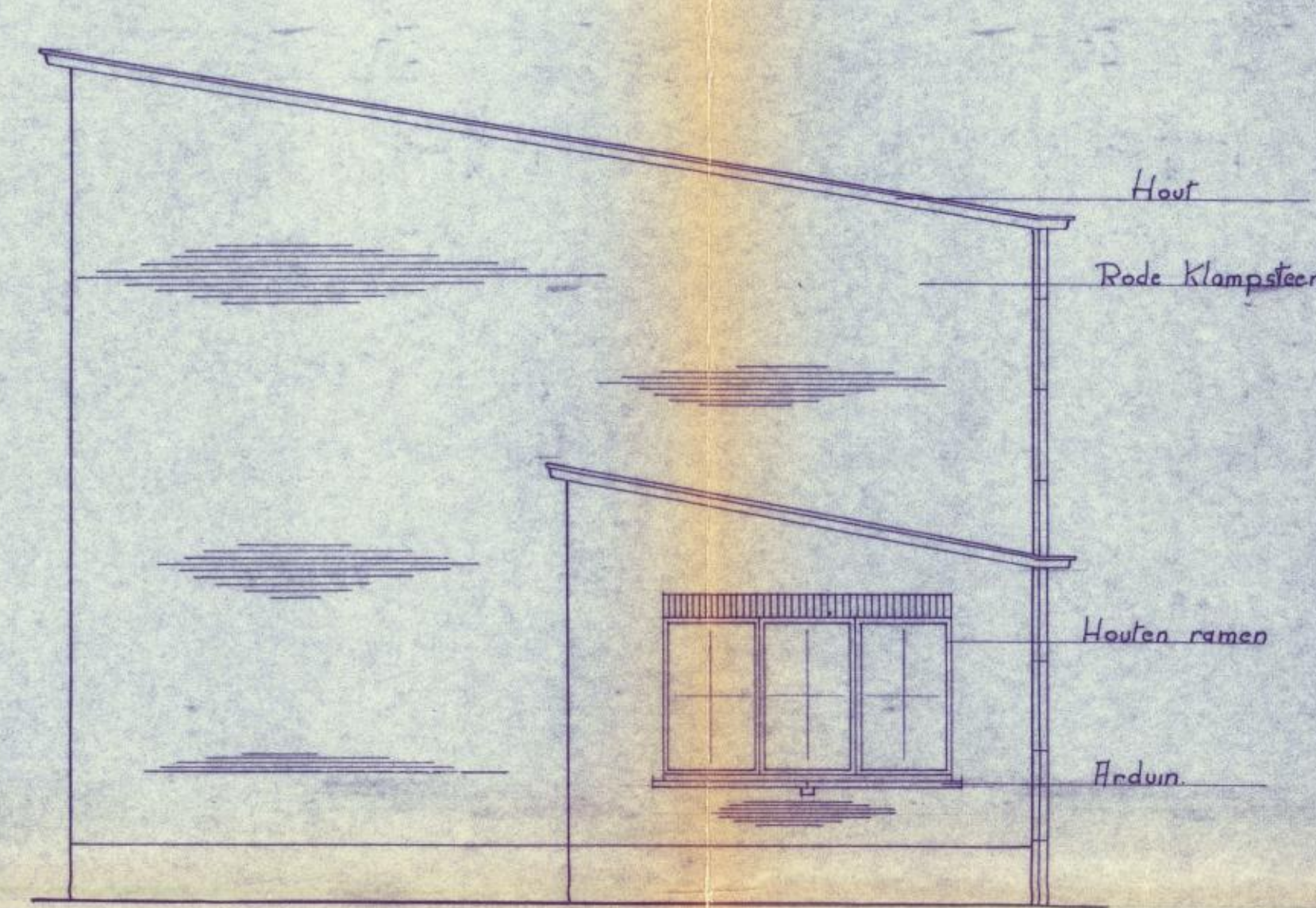

ZUGEVEL



ACHTERGEVEL

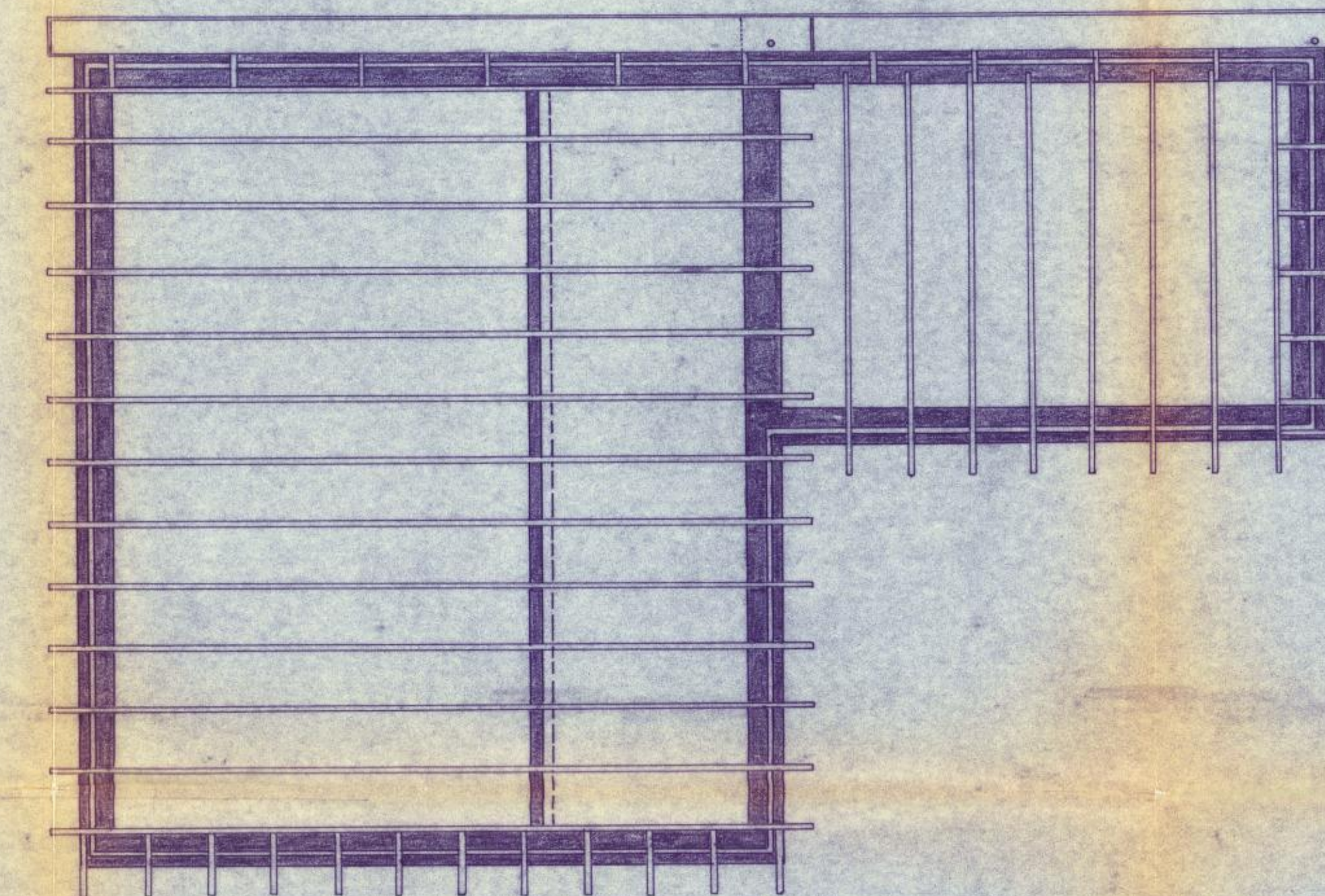

ZOLDERING.

PREMIE-WET 29-5-'48.
 Oppervlakte gelijkvloers 36,50 m²
 Oppervlakte verdieping 38,50 m²
 75,00 m²

VERKLARING.

- Metselwerken + steenslag beton.
- Gewapende beton + gewelven.
- Blauwe hardsteen.
- Zandbreuksteen.

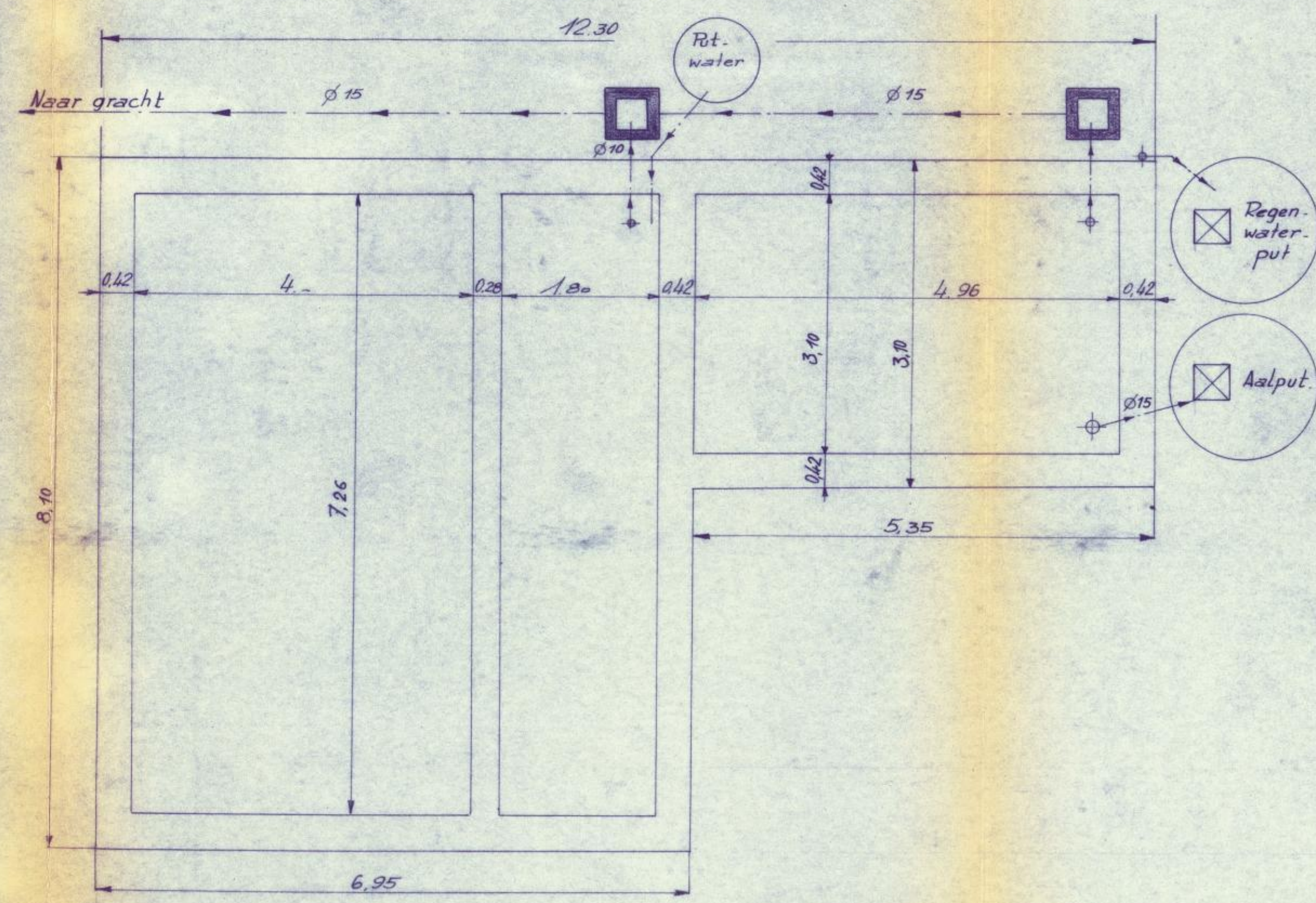

FUNDERINGEN.

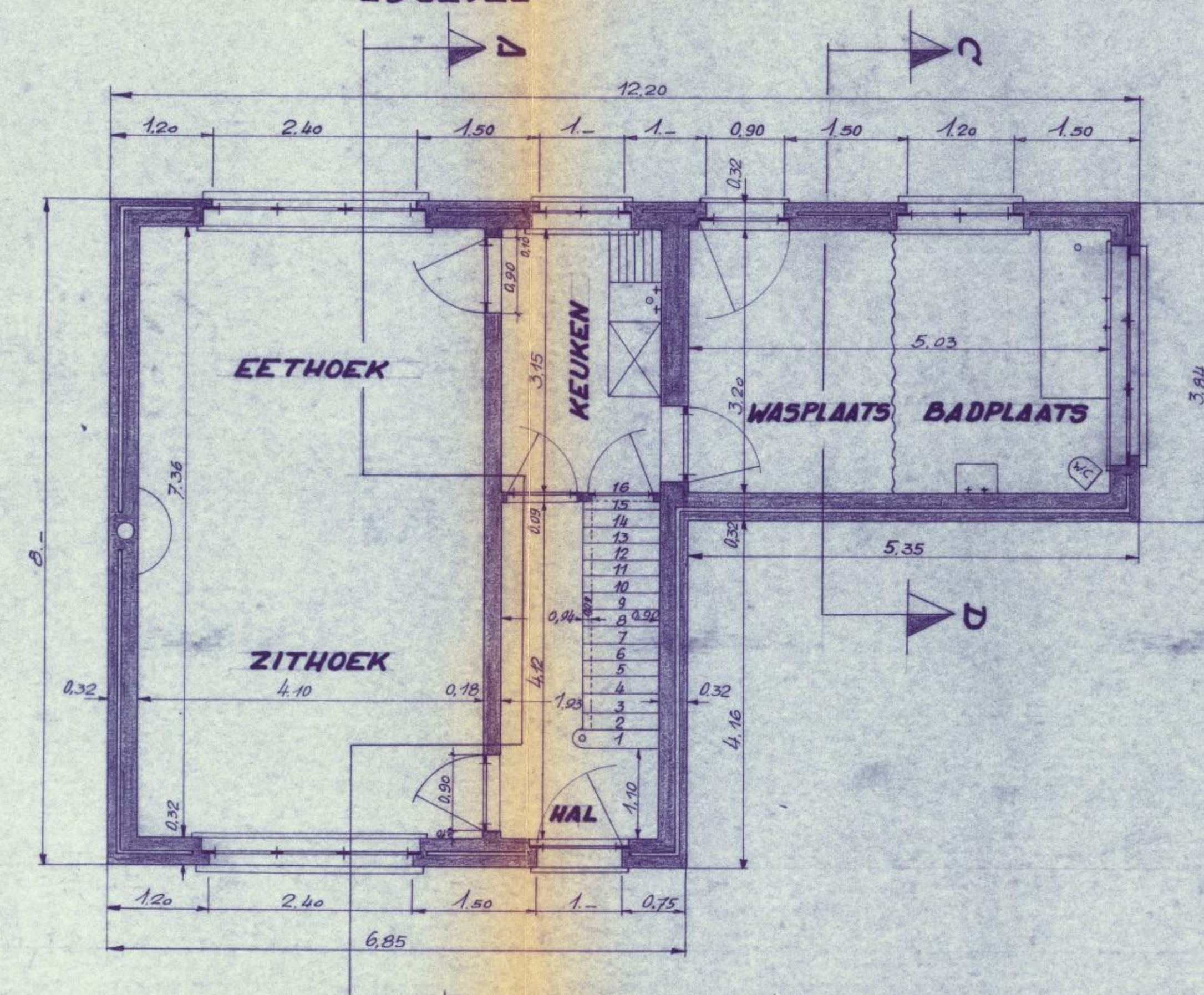

GELUKVLOERS.

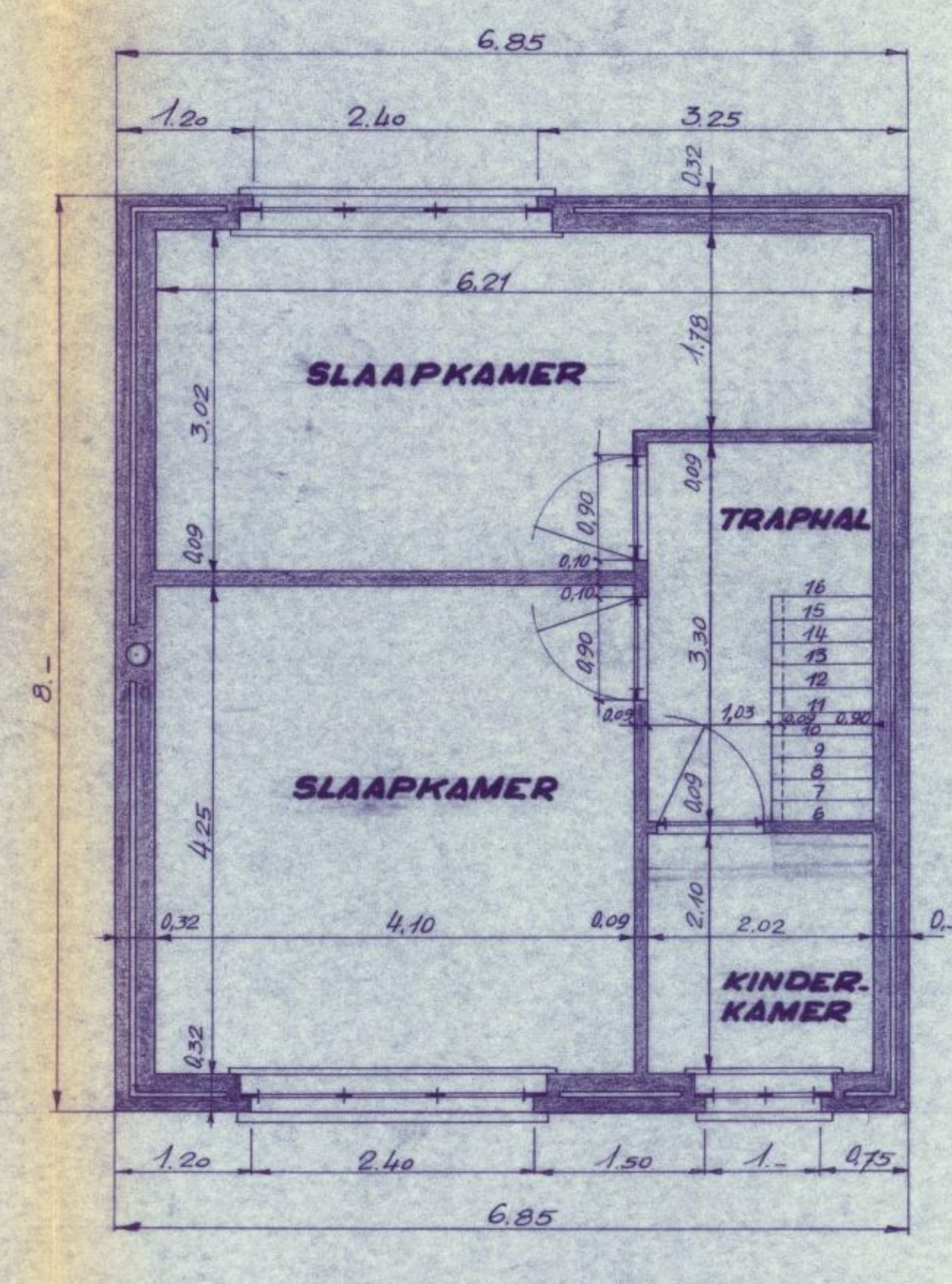

VERDIEPING.

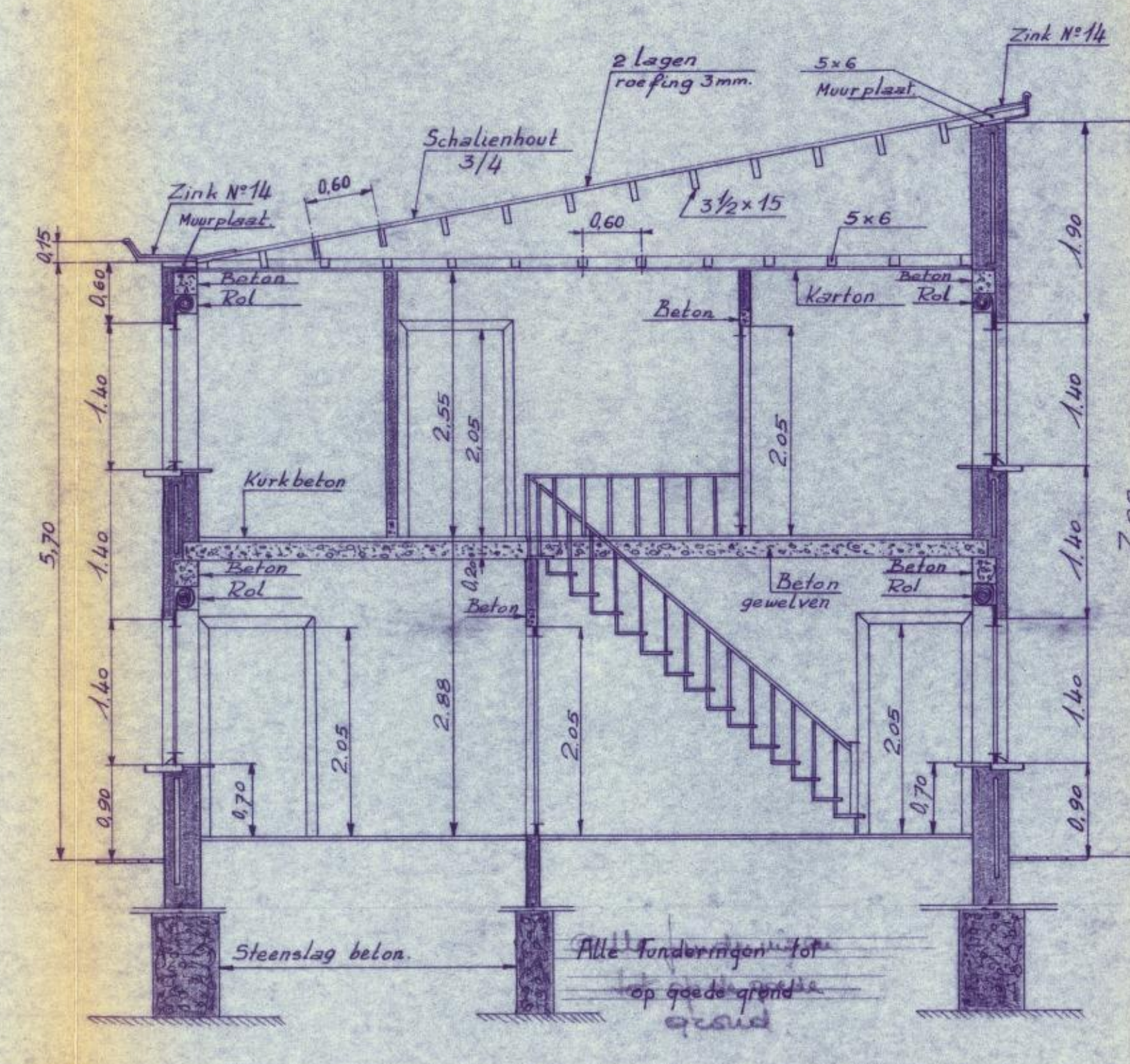

DOORSNEDE A. B.

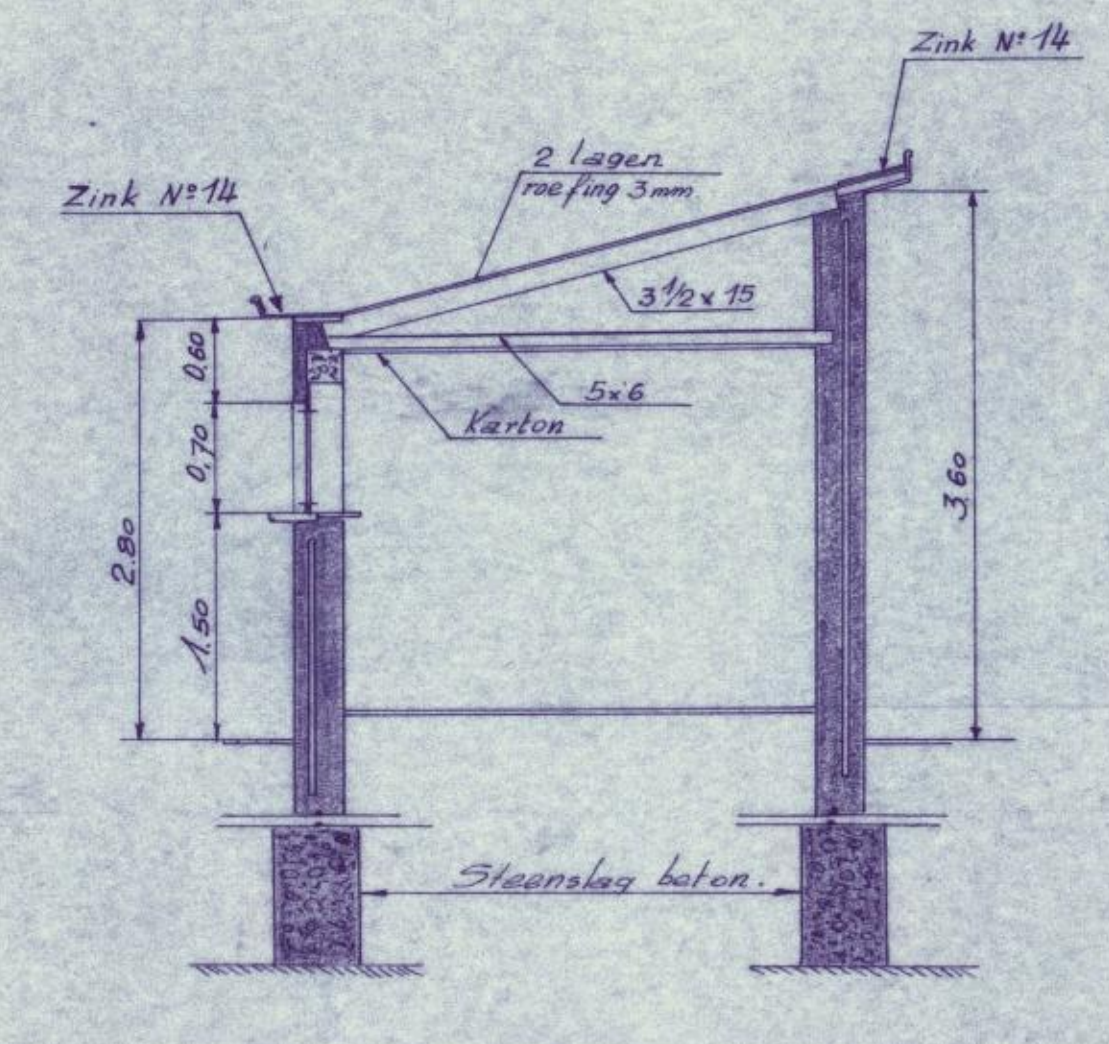

DOORSNEDE C. D.

AANVRAAG.

TOT HET BOUWEN VAN EEN WOONST
 OP DE BREDESTRAAT TE PUTTE
 OOK GENAAMD MOLENHOEK.

VOOR REKENING VAN



PLAN.

SCHAAL 2 cm. per m.

INPLANTINGSPLAN.

Oppervlakte perceel 2500 m².

Oppervlakte open ruimte 2425 m².

SCHAAL 1/500

De Meyer Maurier

